

40W, Ultra wide input, isolated & regulated single output DC/DC converter

### FEATURES

- Ultra wide input voltage range (4:1)
- Enhanced isolation, isolation voltage: 3.0KVDC/1.5KVAC
- Operating temperature range: -40°C to +85°C
- Input Under-voltage Protection, Output short circuit, over-current, over-voltage protection, over-temperature protection
- Meets requirements of railway standard EN50155
- Reverse voltage protection available with A2S(Chassis mounting) or A4S(35mm DIN-Rail mounting)
- International standard pin-out



Patent Protection RoHS

URF1D\_LD-40WR3 series are isolated 40W DC-DC products with 4:1 input voltage. Their feature efficiency up to 91%, 1500VAC / 3000VDC isolation with enhanced isolation, operating temperature of -40°C to +85°C, Input Under-voltage Protection, Output short circuit, over-current, over-voltage, over-temperature protection. Railway vehicle electronic equipment widely used in 72V, 96V and 110V.

### Selection Guide

Certification	Part No. ①	Input Voltage (VDC)		Output		Efficiency <sup>④</sup> (%Min./Typ.) @ Full Load	Max. Capacitive Load(μF)
		Nominal <sup>②</sup> (Range)	Max. <sup>③</sup>	Output Voltage (VDC)	Output Current (mA)(Max./Min.)		
--	URF1D03LD-40WR3	110 (40-160)	170	3.3	10000/0	85/87	10000
	URF1D05LD-40WR3			5	8000/0	86/88	10000
	URF1D12LD-40WR3			12	3333/0	89/91	2700
	URF1D15LD-40WR3			15	2667/0	89/91	1680
	URF1D24LD-40WR3			24	1667/0	87/89	680
	URF1D48LD-40WR3			48	833/0	87/89	470

Note:  
 ①Series with suffix "H" are heat sink mounting; series with suffix "A2S" are chassis mounting, with suffix "A4S" are DIN-Rail mounting, for example URF1D05LD-40WR3A2S is chassis mounting of with heat sink, URF1D05LD-40WR3A4S is DIN-Rail mounting of without heat sink; If the application has a higher requirement for heat dissipation, you can choose modules with heat sink;  
 ②The minimum input voltage and starting voltage of A2S (wiring) and A4S (rail) Model are 1VDC higher than those of DIP package due to input reverse polarity protection function;  
 ③Absolute maximum rating without damage on the converter, but it isn't recommended;  
 ④Efficiency is measured In nominal input voltage and rated output load;A2S (wiring) and A4S (rail) Model due to input reverse polarity protection, minimum efficiency greater than Min.-2 is qualified.

### Input Specifications

Item	Operating Conditions		Min.	Typ.	Max.	Unit
Input Current (full load / no-load)	Nominal input voltage	3.3V output	--	345/5	353/15	mA
		Others	--	413/3	423/15	
Reflected Ripple Current	Nominal input voltage		--	25	--	VDC
Surge Voltage (1sec. max.)			-0.7	--	180	
Starting Voltage	100% load		--	--	40	
Shutdown Voltage			28	32	--	
Starting Time	Nominal input voltage & constant resistance load		--	20	--	ms
Input Filter			Pi filter			
Hot Plug			Unavailable			

Ctrl*	Module switch on	Ctrl suspended or connected to TTL high level (3.5-12VDC)			
	Module switch off	Ctrl pin connected to GND or low level (0-1.2VDC)			
	Input current when switched off	--	2	10	mA

Note: \* the voltage of Ctrl pin is relative to input pin GND.

### Output Specifications

Item	Operating Conditions	Min.	Typ.	Max.	Unit	
Voltage Accuracy	0% -100% load	--	±1	±3	%	
Line Regulation	Full load, the input voltage is from low voltage to high voltage	--	±0.4	±1		
Load Regulation	0% -100% load	--	±0.5	±1		
Transient Recovery Time	25% load step change, nominal input voltage	--	300	500	μs	
Transient Response Deviation		3.3V/5V output	--	±5	±8	%
		Others	--	±3	±5	
Temperature Coefficient	Full load	--	±0.02	±0.03	%/°C	
Ripple & Noise *	20MHz bandwidth, full load	--	150	200	mV p-p	
Trim	Input voltage range	90	-	110	%Vo	
Over-voltage Protection		110	--	160		
Over-current Protection		110	--	190	%Io	
Short circuit Protection		Continuous, self-recovery				

Note: \* 0%-5% load ripple&Noise is no more than 5%Vo. Ripple and noise are measured by "parallel cable" method, please see DC-DC Converter Application Notes for specific operation.

### General Specifications

Item	Operating Conditions	Min.	Typ.	Max.	Unit
Insulation Voltage	Input-output, with the test time of 1 minute and the leak current lower than 1mA	3000	--	--	VDC
	Input-output, with the test time of 1 minute and the leak current lower than 5mA	1500	--	--	VAC
	Input and output respectively on the shell, with the test time of 1 minute and the leak current lower than 1mA.	1500	--	--	VDC
Insulation Resistance	Input-output, isolation voltage 500VDC	1000	--	--	MΩ
Isolation Capacitance	Input-output, 100KHz/0.1V	--	2200	3000	pF
Operating Temperature	see Fig. 1	-40	--	+85	°C
Storage Temperature		-55	--	+125	
Over-temperature Protection		--	100	130	
Storage Humidity	Non-condensing	5	--	95	%RH
Pin Welding Resistance Temperature	Welding spot is 1.5mm away from the casing, 10 seconds	--	--	+300	°C
Switching Frequency*	PWM mode	--	220	--	KHz
Vibration		IEC 61373 car body 1 B mold			
MTBF	MIL-HDBK-217F@25°C	500	--	--	K hours

Note: \* This series of products using reduced frequency technology, the switching frequency is test value of full load, When the load is reduced to below 50%, the switching frequency decreases with decreasing load.

### Physical Specifications

Casing Material		Aluminum alloy	
Package Dimensions	Without heat sink	Horizontal package	50.80*25.40*11.80mm
		A2S wiring package	76.00*31.50*21.20 mm
		A4S rail package	76.00*31.50*25.80 mm
	With heat sink	Horizontal package	51.40*26.20*16.50mm
		A2S wiring package	76.00*31.50*25.30 mm
		A4S rail package	76.00*31.50*29.90 mm

Weight	Without heat sink	Horizontal package/A2S wiring package/A4S rail package	26g/48g/68g(Typ.)
	With heat sink	Horizontal package/A2S wiring package/A4S rail package	34g/56g/76g(Typ.)
Cooling Method			Free air convection

EMC Specifications (EN62368)

EMI	CE	CISPR32/EN55032	CLASS B(see Fig. 4-①/4-③ for recommended circuit)	
	RE	CISPR32/EN55032	CLASS B (see Fig. 4-①/4-③ for recommended circuit)	
EMS	ESD	IEC/EN61000-4-2	Contact ±6KV/Air ±8KV	perf. Criteria A
	RS	IEC/EN61000-4-3	20V/m	perf. Criteria A
	EFT	IEC/EN61000-4-4	100kHz ±4KV (see Fig.4-②/4-④ for recommended circuit)	perf. Criteria A
	Surge	IEC/EN61000-4-5	line to line ±2KV (2Ω 18uF see Fig.4-②/4-④ for recommended circuit)	perf. Criteria A
	CS	IEC/EN61000-4-6	10 Vr.m.s	perf. Criteria A

EMC Specifications (EN50155)

EMI	CE	EN50121-3-2	150kHz-500kHz 99dBuV (see Fig. 4-①/4-③ for recommended circuit)	
	RE	EN55016-2-1	500kHz-30MHz 93dBuV (see Fig. 4-①/4-③ for recommended circuit)	
EMS	ESD	EN50121-3-2	Contact ±6KV/Air ±8KV	perf. Criteria A
	RS	EN50121-3-2	20V/m	perf. Criteria A
	EFT	EN50121-3-2	±2kV 5/50ns 5kHz (see Fig .4-②/4-④ for recommended circuit)	perf. Criteria A
	Surge	EN50121-3-2	line to line ±1KV (42Ω , 0.5 μ F) (see Fig .4-②/4-④ for recommended circuit)	perf. Criteria A
	CS	EN50121-3-2	0.15MHz-80MHz 10 Vr.m.s	perf. Criteria A

Product Characteristic Curve

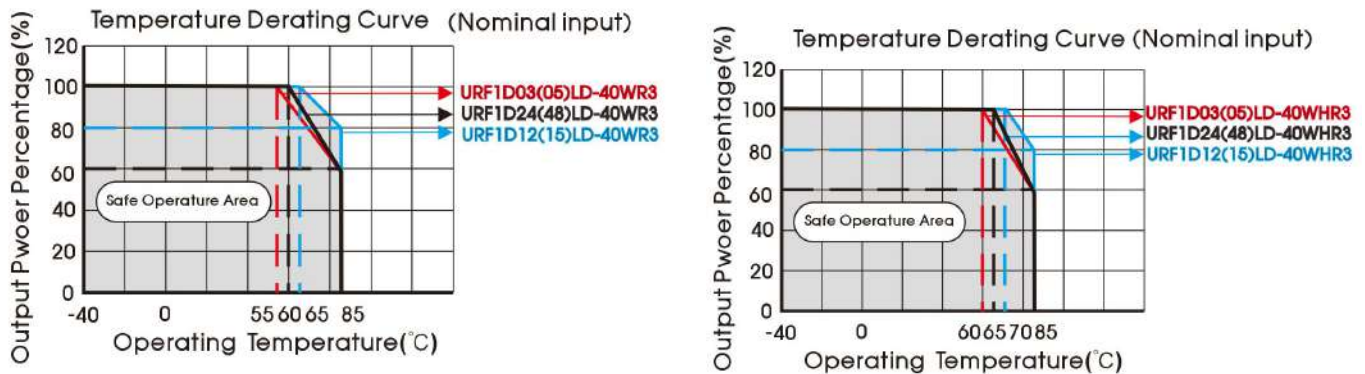

Fig. 1

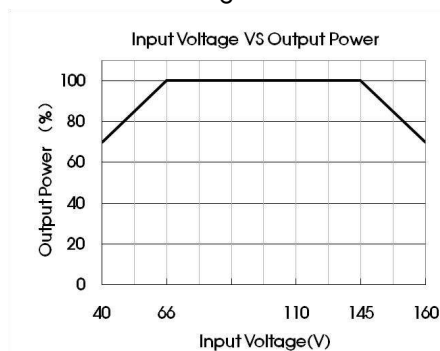
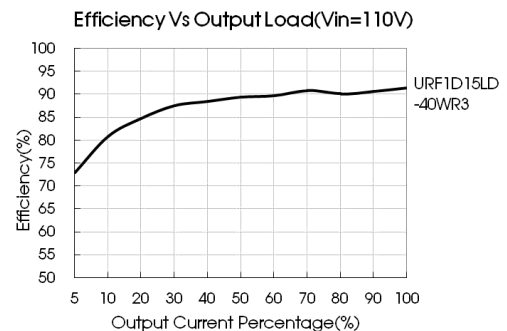
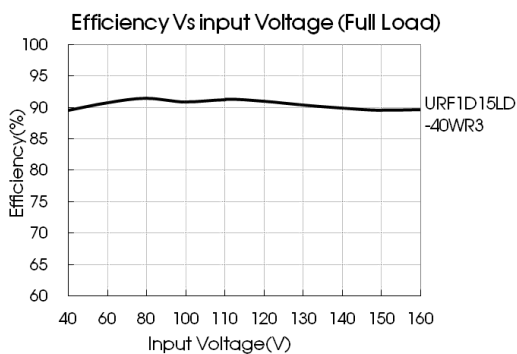
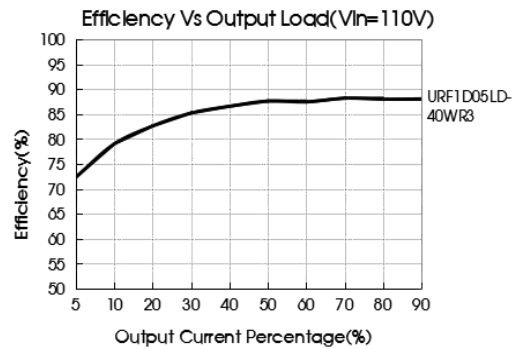
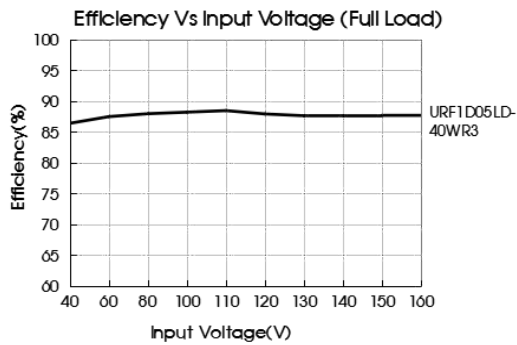

Fig. 2

Note: Fig. 2 is input voltage VS output power Derating Curve, The Fig. 2 is for reference only, please refer to the actual product. The product can working well at nominal input voltage and output load when the casing temperature does not exceed 100°C.



## Design Reference

### 1. Typical application

All the DC/DC converters of this series are tested according to the recommended circuit (see Fig. 3) before delivery.

If it is required to further reduce input and output ripple, properly increase the input & output of additional capacitors  $C_{in}$  and  $C_{out}$  or select capacitors of low equivalent impedance provided that the capacitance is no larger than the max. capacitive load of the product.

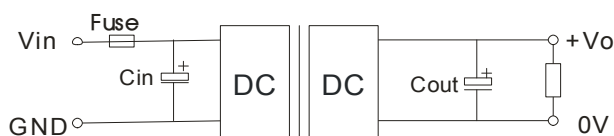

Fig. 3

Vout(VDC)	Fuse	Cin	Cout
3.3/5	2A, slow blow	100 $\mu$ F	470 $\mu$ F
12/15			220 $\mu$ F
24/48			100 $\mu$ F

### 2. EMC module solution-recommended circuit

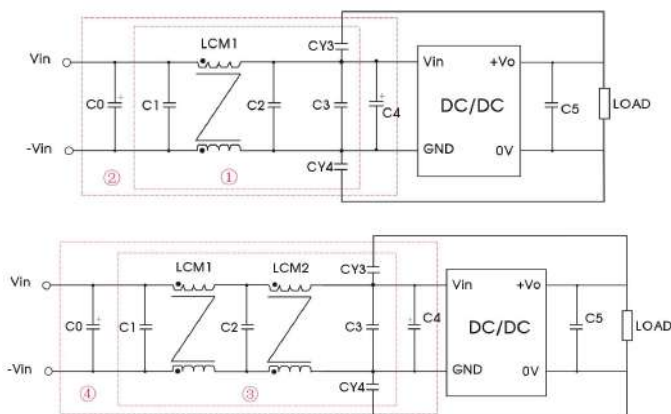

Fig. 4

Notes: 1.Part ① in the Fig. 4 is used for 3.3V/5V/12V/15V/24V output EMI test and part ② for EMI test, selected based on needs.

2.Part ③ in the Fig. 4 is used for 48V output EMI test and part ④ for EMI test, selected based on needs.

Fig.4 Parameter description:

C0 / C4	100 $\mu$ F/200V
C1 / C2	2.2 $\mu$ F/250V
C3	Refer to the $C_{in}$ in Fig.3
LCM1	15mH UU commonmode choke
LCM2	2.2mH, recommended to use MORNSUN's FL2D-30-22Z
CY1 / CY2	2200pF/400VAC
C5	Refer to the $C_{out}$ in Fig.3

3. Trim application & Trim resistance

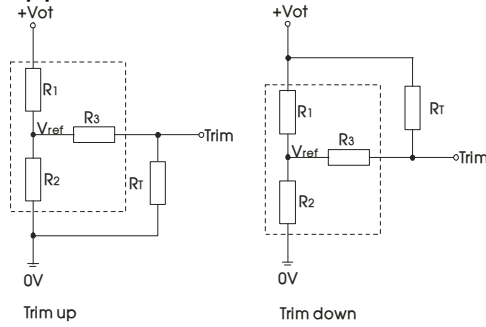

Calculation formula of Trim resistance:

$$\begin{aligned} \text{up: } R_T &= \frac{\alpha R_2}{R_2 - \alpha} - R_3 & \alpha &= \frac{V_{ref}}{V_o' - V_{ref}} \cdot R_1 \\ \text{down: } R_T &= \frac{\alpha R_1}{R_1 - \alpha} - R_3 & \alpha &= \frac{V_o' - V_{ref}}{V_{ref}} \cdot R_2 \end{aligned}$$

Note: Leave open if not used. R<sub>T</sub>: Resistance of Trim. α: User-defined parameter, no actual meanings.

Application circuit for TRIM (Part in broken line is the interior of models)

Vout(V)	R1(KΩ)	R2(KΩ)	R3(KΩ)	Vref(V)
3.3	4.801	2.87	10	1.24
5	2.883	2.87	10	2.5
12	11.000	2.87	15	2.5
15	14.384	2.87	15	2.5
24	24.872	2.87	17.8	2.5
48	55.28	3.0	20	2.5

4. Reflected Ripple Current testing peripheral circuit

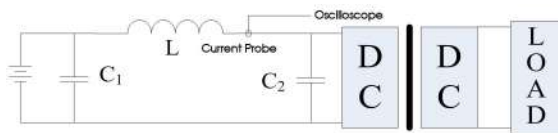

Fig.5

Fig.5 Parameter description :	
C1	220uF, ESR<1.0Ω at 100KHz
L	4.7uH
C2	4.7uF/250V

5. It is not allowed to connect modules output in parallel to enlarge the power

6. For more information please find DC-DC converter application notes on [www.mornsun-power.com](http://www.mornsun-power.com)

Horizontal Package (without heat sink) Dimensions and Recommended Layout

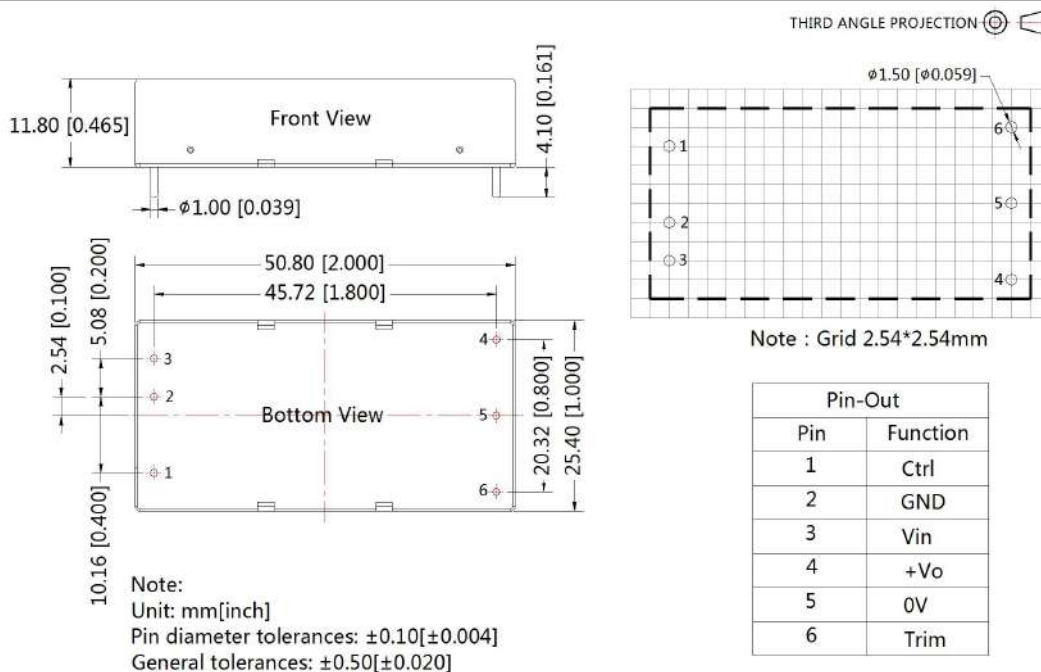

Horizontal Package (with heat sink) Dimensions

THIRD ANGLE PROJECTION 

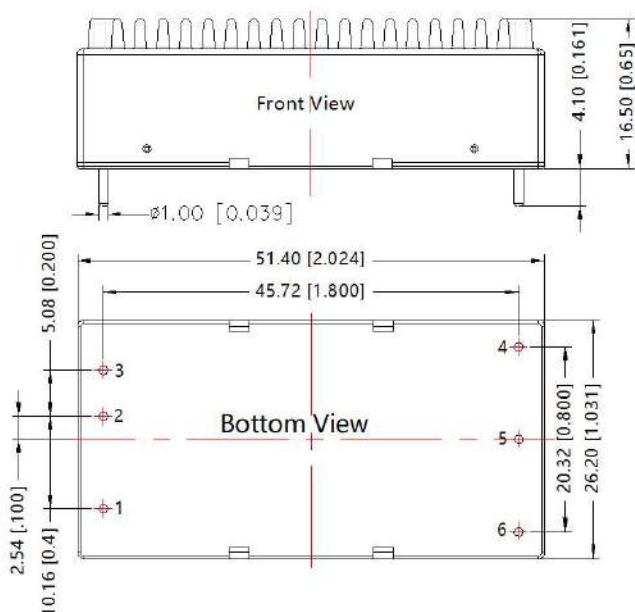

Pin-Out	
Pin	Function
1	Ctrl
2	GND
3	Vin
4	+Vo
5	0V
6	Trim

Note:  
Unit: mm[inch]  
General tolerances:  $\pm 0.50[\pm 0.020]$

URF1D\_LD-40WR3A2S (without heatsink) Dimensions

THIRD ANGLE PROJECTION 

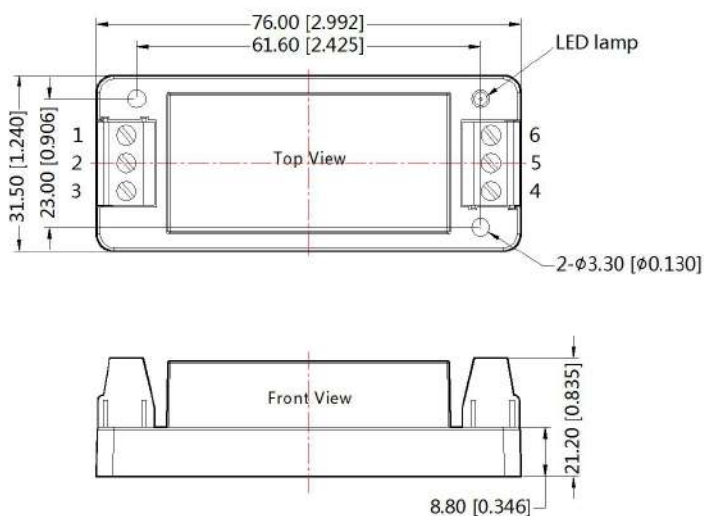

Pin-Out						
Pin	1	2	3	4	5	6
Function	Ctrl	GND	Vin	+Vo	0V	Trim

Note:  
Unit: mm[inch]  
Wire range: 24-12 AWG  
Tightening torque: Max 0.4 N·m  
General tolerances:  $\pm 0.50[\pm 0.020]$

URF1D\_LD-40WR3A2S (with heatsink) Dimensions

THIRD ANGLE PROJECTION 

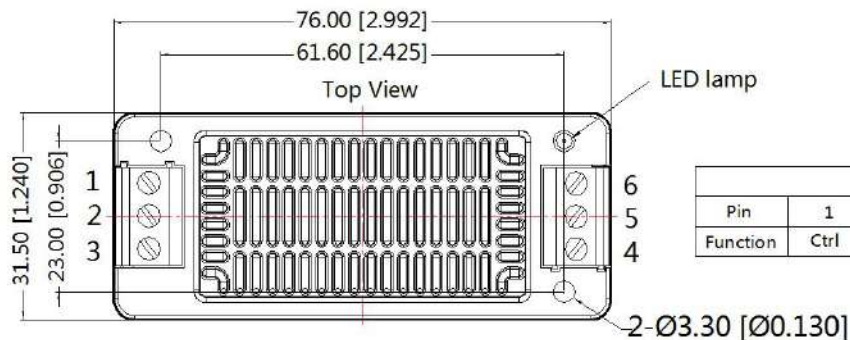

Pin-Out						
Pin	1	2	3	4	5	6
Function	Ctrl	GND	Vin	+Vo	0V	Trim

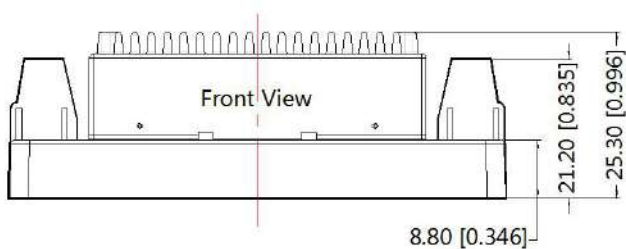

Note:  
Unit: mm[inch]  
Wire range: 24-12 AWG  
Tightening torque: Max 0.4 N·m  
General tolerances: ±1.00[±0.039]

URF1D\_LD-40WR3A4S (without heatsink) Dimensions

THIRD ANGLE PROJECTION 

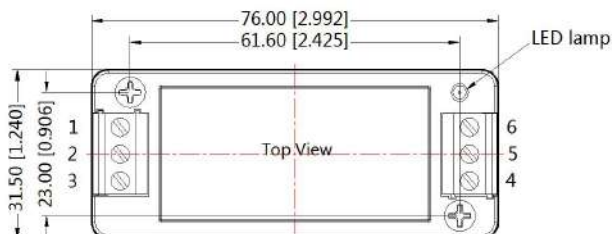

Pin-Out						
Pin	1	2	3	4	5	6
Function	Ctrl	GND	Vin	+Vo	0V	Trim

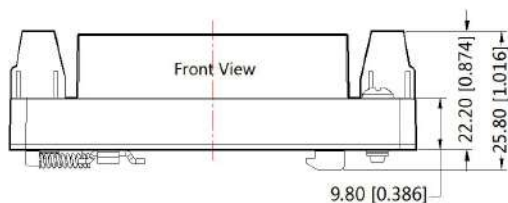

Note:  
Unit: mm[inch]  
Mounting rail: TS35  
Wire range: 24-12 AWG  
Tightening torque: Max 0.4 N·m  
General tolerances: ±1.00[±0.039]

URF1D\_LD-40WHR3A4S (with heatsink) Dimensions

THIRD ANGLE PROJECTION 

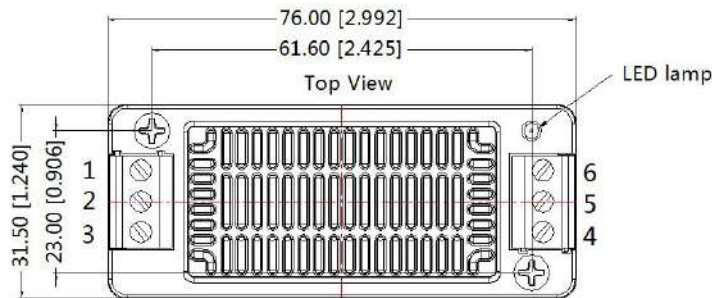

Pin-Out						
Pin	1	2	3	4	5	6
Function	Ctrl	GND	Vin	+Vo	0V	Trim

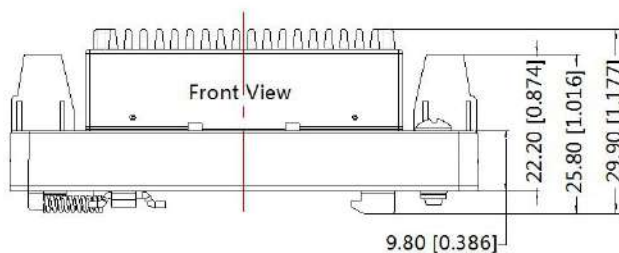

Note:  
Unit: mm[inch]  
Mounting rail: TS35  
Wire range: 24-12 AWG  
Tightening torque: Max 0.4 N·m  
General tolerances:  $\pm 1.00[\pm 0.039]$

Note:

1. Packing information please refer to Product Packing Information which can be downloaded from [www.mornsun-power.com](http://www.mornsun-power.com). The Packing bag number of Horizontal package :58200035(without heat sink), 58200051(with heat sink), A2S/ A4S package number: 58220022;
2. The maximum capacitive load offered were tested at input voltage range and full load;
3. Unless otherwise specified, parameters in this datasheet were measured under the conditions of  $T_a=25^{\circ}\text{C}$ , humidity<75%RH with nominal input voltage and rated output load;
4. All index testing methods in this datasheet are based on Company's corporate standards;
5. Other product application information, please see DC-DC (railway power supply) Converter Application Notes for specific operation methods;
6. We can provide product customization service, please contact our technicians directly for specific information;
7. Products are related to laws and regulations: see "Features" and "EMC";
8. Our products shall be classified according to ISO14001 and related environmental laws and regulations, and shall be handled by qualified units.

Mornsun Guangzhou Science & Technology Co., Ltd.

Address: No. 5, Kehui St. 1, Kehui Development Center, Science Ave., Guangzhou Science City, Luogang District, Guangzhou, P. R. China  
Tel: 86-20-38601850-8801 Fax: 86-20-38601272 E-mail: [info@mornsun.cn](mailto:info@mornsun.cn)