

Non-isolated & regulated 10A, 16A single output
POL power converter

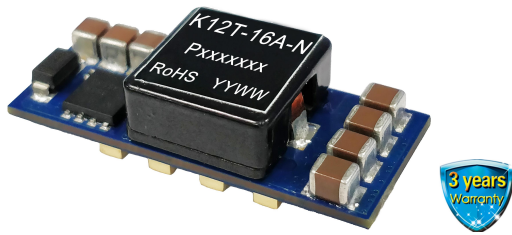

CE RoHS

FEATURES

- High efficiency up to 96%
- Operating ambient temperature range: -40°C ~ +85°C
- Input under-voltage protection, output short-circuit, over-current protection
- High-speed transient response
- Compact SMD package
- EN62368 approved

K12T-10A, 16A series is a 10A, 16A non-isolated switching regulator. The output voltage is accurately adjustable from 0.75V to 5.0V, and the product is featured with high efficiency, fast transient response, input under-voltage, output short circuit, over-current protection. They meet CLASS B of CISPR32/EN55032 EMI standards by adding the recommended external components and they are widely used in applications such as communications, computer network industry, power distributed architecture, workstations, servers, LANs/WANs and provide high current with fast transient response for high-speed chips such as FPGA, DSP, and ASIC.

Selection Guide

Certification	Part No. ^①	Input Voltage (VDC)		Output		Efficiency(%) Min./Typ.	Capacitive Load(μF) Max.	
		Nominal (Range)	Max. ^②	Voltage(VDC) ^③ (Range)	Current (A) Max./Min.		1 mΩ ≤ ESR < 10 mΩ	ESR ≥ 10 mΩ
CE	K12T-10A-P	12 (8.3~14)	15	0.75~5.0	10/0	93/96	5000	6000
	K12T-10A-N							
	K12T-16A-P				16/0		5000	6000
	K12T-16A-N							

Notes: ① "P" indicates that the Ctrl pin is positive logic control, "N" indicates that the Ctrl pin is negative logic control;

② Exceeding the maximum input voltage may cause permanent damage;

③ The default output voltage is 0.75VDC, which can be adjusted to 1.2VDC, 1.8VDC, 2.5VDC, 3.3VDC, 5VDC. See Trim instructions for specific output voltage adjustment;

④ Unless otherwise specified, parameters in this table were measured under the 5VDC output voltage.

Input Specifications

Item	Operating Conditions		Min.	Typ.	Max.	Unit
Input Current (no-load)	Nominal input voltage	K12T-10A-P(N)	--	4340/70	--	mA
		K12T-16A-P(N)	--	7020/70	--	
Start-up Voltage			--	--	8.3	VDC
Under-voltage Protection			6.0	--	--	
Reverse Polarity Input			Avoid / Not protected			
Hot Plug			Unavailable			
Input Filter			Capacitance filter			
Ctrl*	Module on	K12T-10A-P, K12T-16A-P (Positive logic)	Ctrl pin open or pulled high (Vin-2.5VDC ~ Vin)			
		K12T-10A-N, K12T-16A-N (Negative logic)	Ctrl pin pulled low to GND (0 ~ 0.5VDC)			
	Module off	K12T-10A-P, K12T-16A-P (Positive logic)	Ctrl pin pulled low to GND (0 ~ 0.5VDC)			
		K12T-10A-N, K12T-16A-N (Negative logic)	Ctrl pin open or pulled high (Vin-2.5VDC ~ Vin)			
	Input current when off		--	2	--	mA

Notes: * 1. The Ctrl pin voltage is referenced to GND;

2. Unless otherwise specified, parameters in this table were measured under the 5VDC output voltage.

Output Specifications

Item	Operating Conditions	Min.	Typ.	Max.	Unit
Voltage Accuracy	Full load, nominal input voltage	--	±1.0	±2.0	%
Linear Regulation	Full load, input voltage range	--	±0.3	--	

Load Regulation	Nominal input, 0% -100% load	--	±0.4	--	%
Ripple & Noise*	20MHz bandwidth, nominal input, 100% load	--	65	100	mVp-p
Trim		0.75	--	5.0	VDC
Sense		--	--	110	%Vo
Transient Response Deviation	Nominal input, 50%-100%-50% load step change, di/dt=2.5A/us, with external 470 µF polymer capacitors	K12T-10A	--	±75	mV
		K12T-16A	--	±100	mV
Transient Recovery Time		K12T-10A, K12T-16A		20	us
Over-current Protection	Nominal input	K12T-10A	--	320	%Io
		K12T-16A	--	200	%Io
Short-circuit Protection	Nominal input	Continuous, self-recovery			
Temperature Coefficient	100% load	--	±0.02	--	%/°C

Notes: * 1. The "parallel cable" method is used for Ripple and Noise test, please refer to DC-DC Converter Application Notes for specific information;
2. Unless otherwise specified, parameters in this table were measured under the 5VDC output voltage.

General Specifications

Item	Operating Conditions	Min.	Typ.	Max.	Unit
Operating Temperature	See Fig. 1	-40	--	+85	°C
Storage Temperature		-55	--	+125	
Storage Humidity	Non-condensing	5	--	95	%RH
Reflow Soldering Temperature		Peak temp. Tc ≤245°C, maximum duration time ≤60s over 217°C. For actual application, please refer to IPC/JEDEC J-STD-020D.1.			
Switching Frequency	Full load, nominal input voltage input	--	300	--	KHz
MTBF	MIL-HDBK-217F@25°C	1000	--	--	K hours

Mechanical Specifications

Dimensions	33.00 x 13.50 x 8.30mm
Weight	8.6g (Typ.)
Cooling Method	Nature convection or forced convection

Electromagnetic Compatibility (EMC)

Emissions	CE	CISPR32/EN55032 Class B (see Fig.3 for recommended circuit)	
	RE	CISPR32/EN55032 Class B (see Fig.3 for recommended circuit)	
Immunity	ESD	IEC/EN61000-4-2 Contact ±6KV	perf. Criteria B

Typical Characteristic Curves

K12T-10A Series Temperature Derating Curves

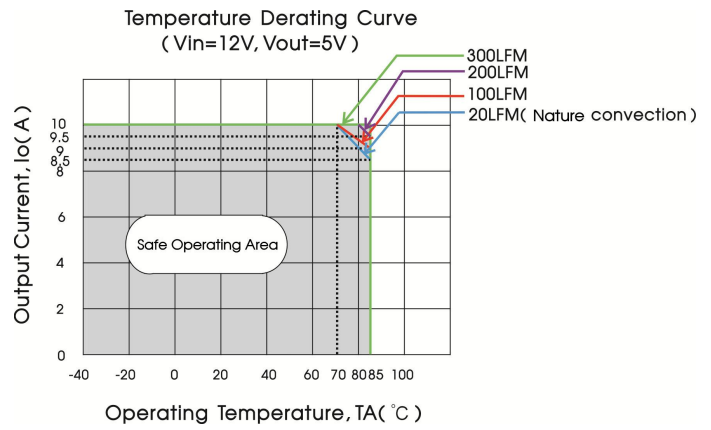
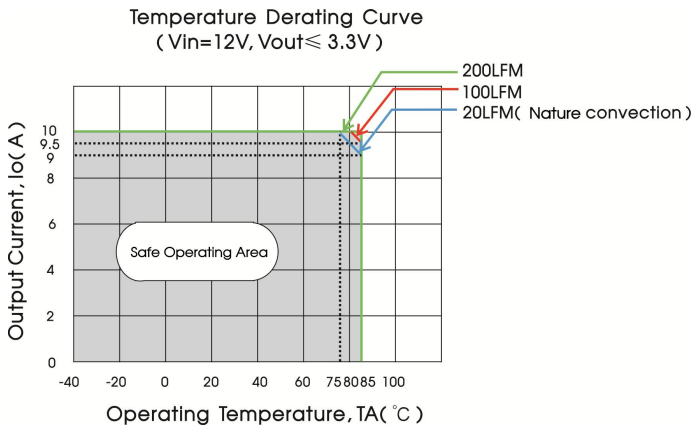

K12T-16A Series Temperature Derating Curves

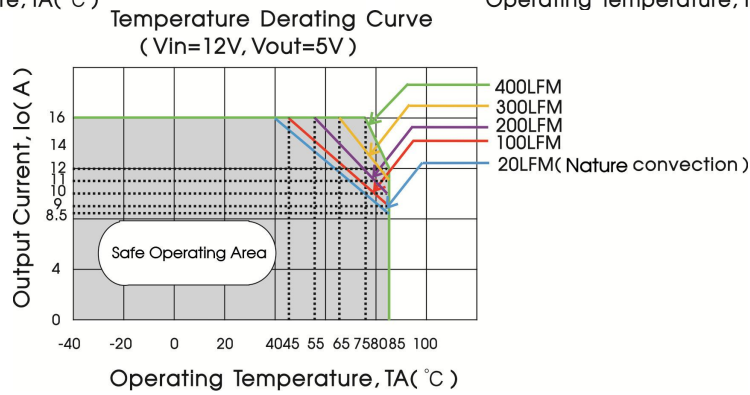
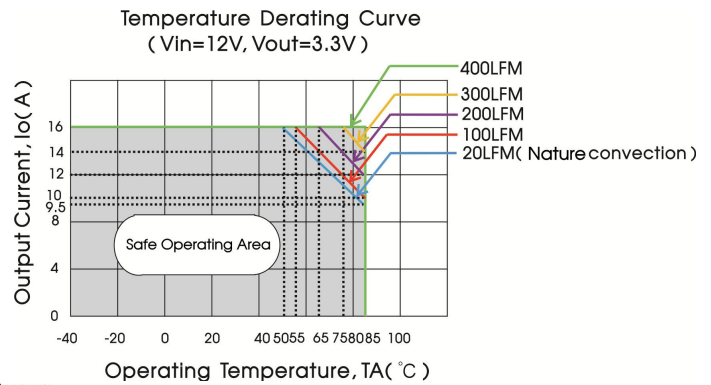
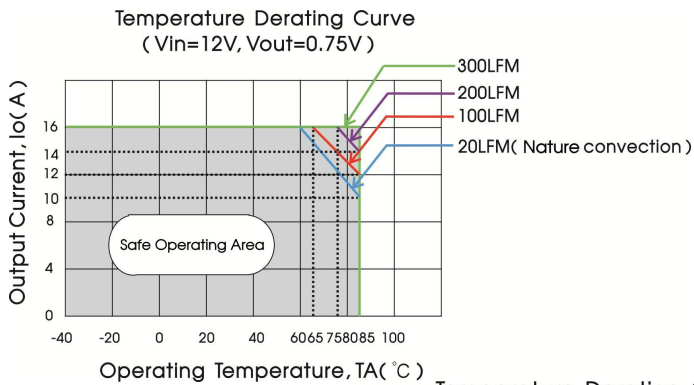

K12T-10A Series Efficiency Curves

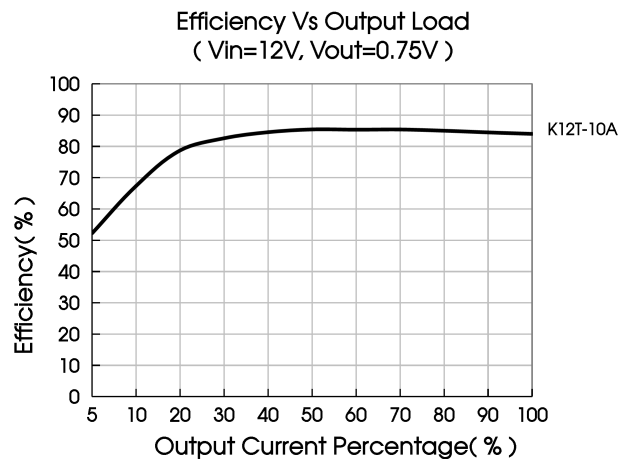
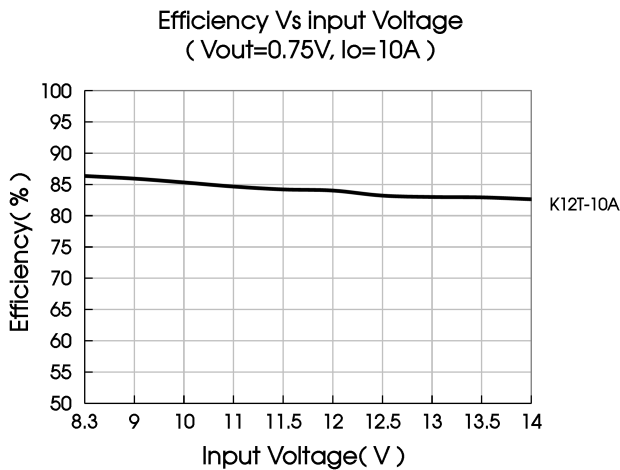

Efficiency Vs input Voltage
($V_{out}=5V, I_o=10A$)

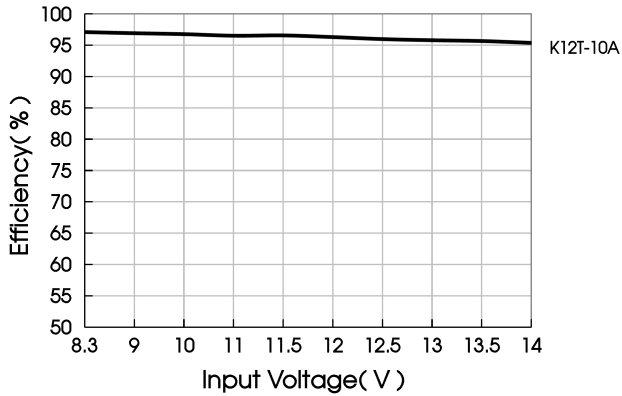

Efficiency Vs Output Load
($V_{in}=12V, V_{out}=5V$)

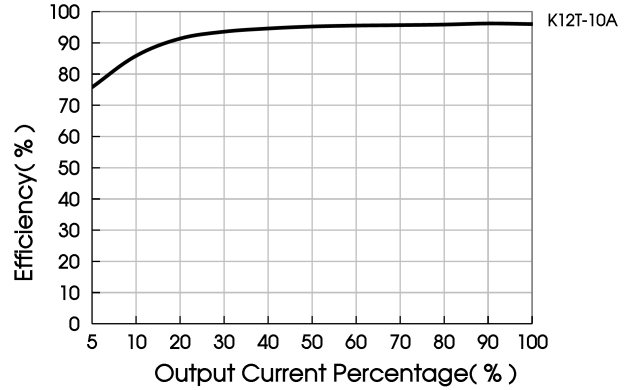

K12T-16A Series Efficiency Curves

Efficiency Vs input Voltage
($V_{out}=1.2V, I_o=16A$)

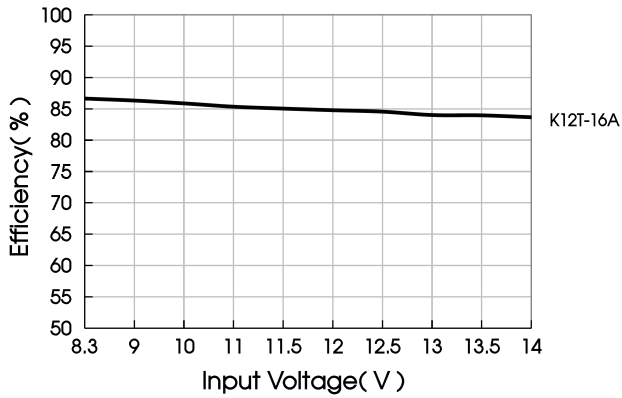

Efficiency Vs Output Load
($V_{in}=12V, V_{out}=1.2V$)

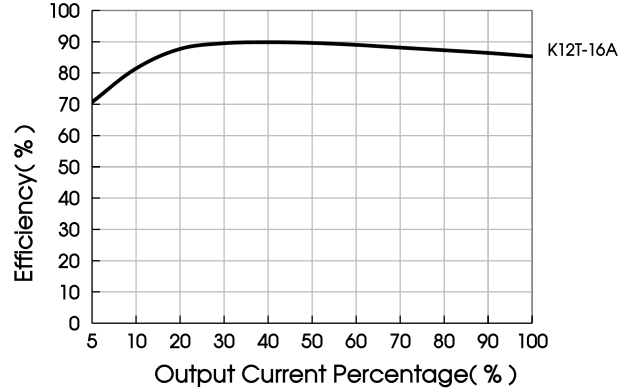

Efficiency Vs input Voltage
($V_{out}=3.3V, I_o=16A$)

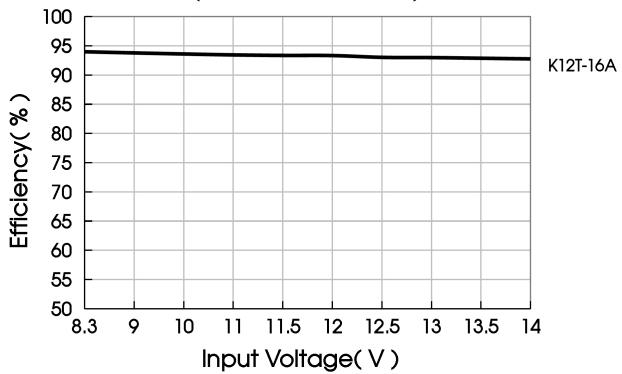

Efficiency Vs Output Load
($V_{in}=12V, V_{out}=3.3V$)

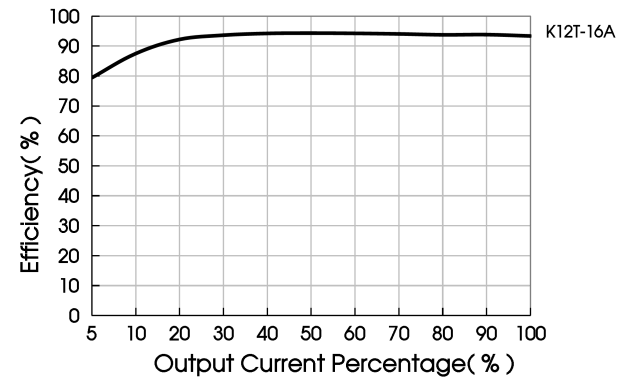

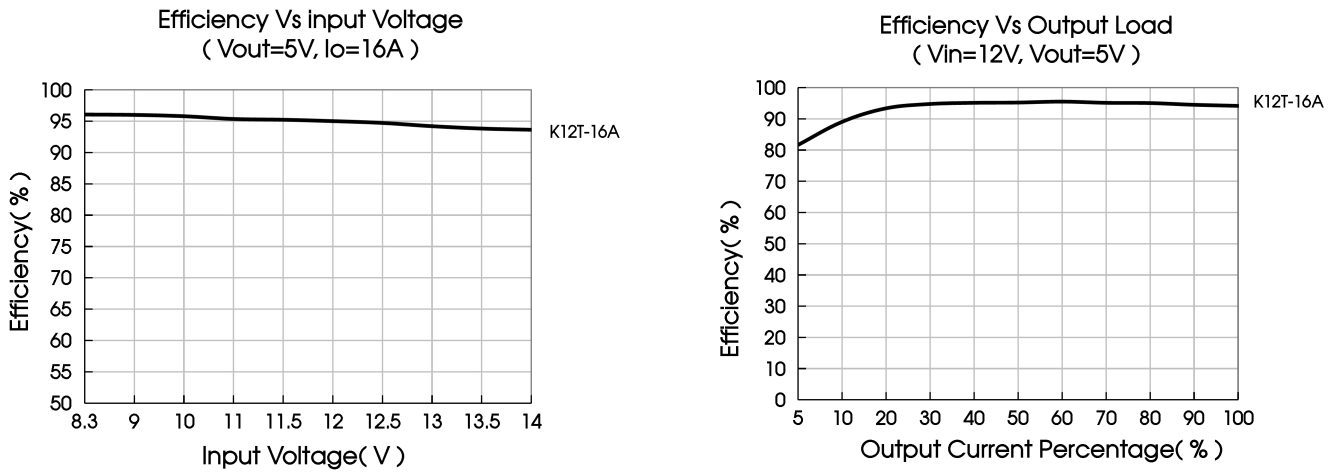
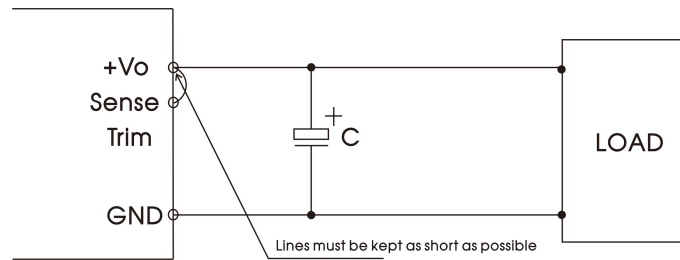

Fig. 1

Remote Sense Application

1. Remote sense connection if not used



Notes:

1. If the sense function is not used for remote regulation the user must connect the Sense to +Vo at the DC-DC converter pins and will compensate for voltage drop across pins only;
2. The connections between Sense and +Vo must be kept as short as possible, otherwise they may be picking up noise, interference and/or causing unstable operation of the power module.

2. Remote sense connection used for compensation

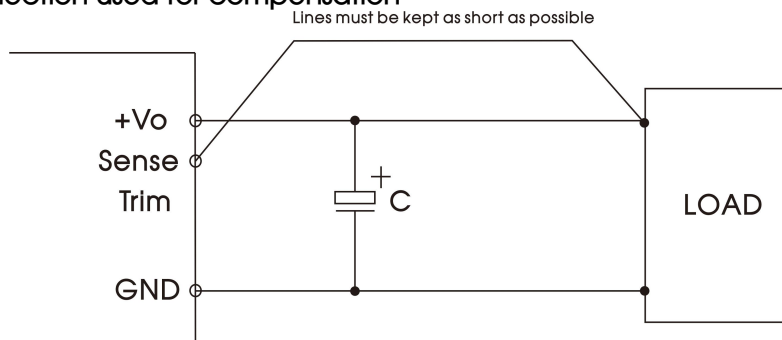

Notes:

1. PCB-tracks or cables/wires for Remote Sense must be kept as short as possible;
2. Using remote sense with long wires long wires may cause unstable operation. Note that large wire impedance may cause oscillation of the output voltage and/or increased ripple. Consult technical support or factory for further advice of sense operation;
3. We recommend using adequate cross section for PCB-track layout and/or cables to connect the power supply module to the load in order to keep the voltage drop below 0.3V and to make sure the power supply's output voltage remains within the specified range.

Design Reference

1. Typical application

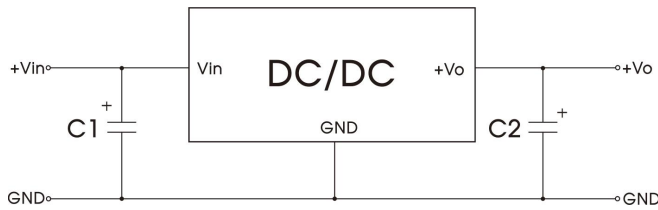

Fig. 2

Notes:

1. 100 μF or 220 μF capacitor (C1) and 22 μF or 47 μF capacitor (C2) are required and should be connected close to the pin terminal, to ensure the stability of the converter;
2. To reduce the output ripple furtherly, increased values and/or tantalum or low ESR polymer capacitors may also be used instead;
3. Refer to Table 1 for C1 and C2 capacitor values;
4. Converter cannot be used for hot swap and with output in parallel.

Table 1

Part No.	C1	C2
K12T-10A-P(N)	100μF/35V	22μF/16V
K12T-16A-P(N)	220μF/35V	47μF/16V

2. EMC compliance circuit

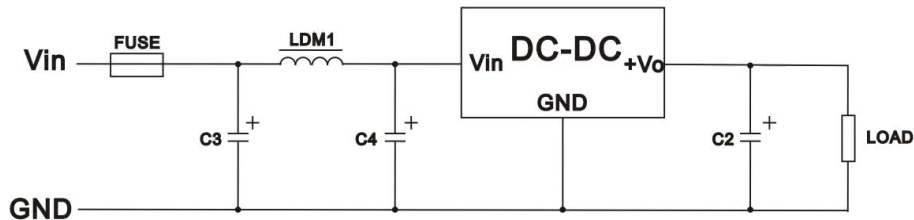

Fig. 3

Table 2

EMI	FUSE	C3/C4	LDM1	C2
CE	Selected based on the actual input current in application	1000μF /35V	6.8μH	Refer to the Cout in Table 1
RE		100μF /35V		

3. Trim function for output voltage adjustment (open if unused)

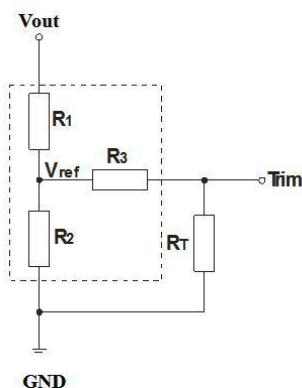

Fig. 4 TRIM resistor connection (dashed line shows internal resistor network)

Table 3

Vo (VDC)	R _T (kΩ)
0.7525	Open
1.2	15.089
1.8	5.873
2.5	3.120
3.3	1.826
5	0.695

Calculating Trim resistor (RT) values: :

$$R_T (\Omega) = \frac{7200}{V_O - 0.7525} - 1000$$

- Notes: 1. R_T : Resistance of Trim; Vo: The trim up voltage;
2. If R_T = ∞ or Trim pin open, Vo = 0.7525 VDC.

4. For additional information please refer to DC-DC converter application notes on www.mornsun-power.com

Dimensions and Recommended Layout

THIRD ANGLE PROJECTION 

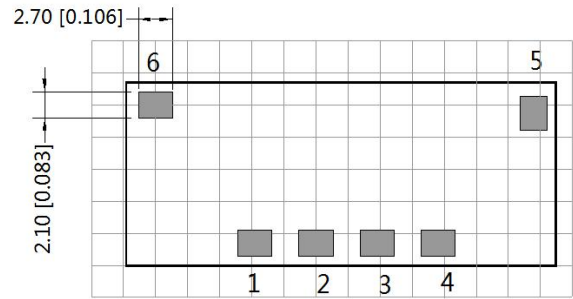
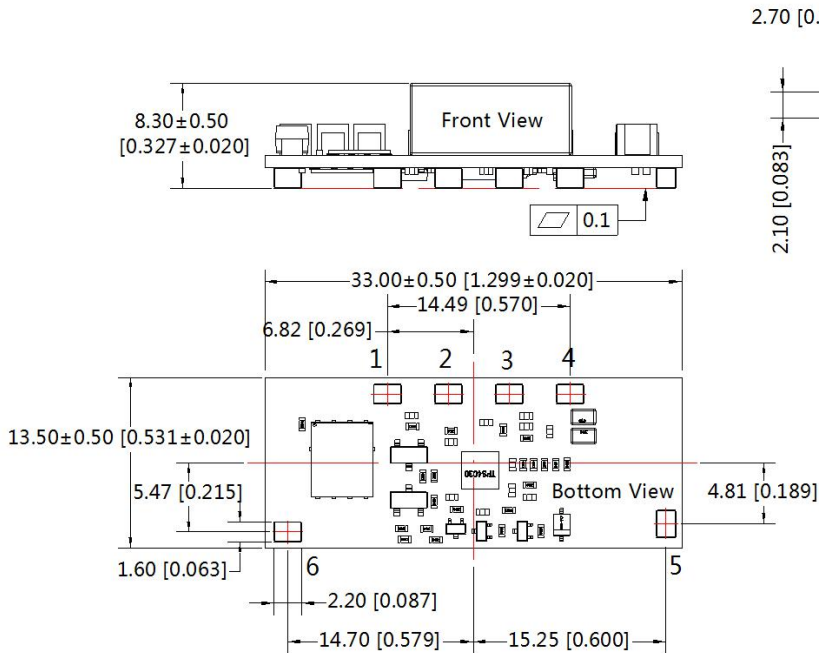

Note : Grid: 2.54*2.54mm

Pin-Out	
Pin	Function
1	GND
2	+Vo
3	Trim
4	Sense
5	Ctrl
6	Vin

Note :
Unit: mm[inch]
General tolerances: ± 0.25 [± 0.010]
The layout of the device is for reference only ,
please refer to the actual product

Notes:

- For additional information on Product Packaging please refer to www.mornsun-power.com. Packaging bag number: 58210071;
- The maximum capacitive load offered were tested at input voltage range and full load;
- Unless otherwise specified, parameters in this datasheet were measured under the conditions of $T_a=25^\circ\text{C}$, humidity<75%RH with nominal input voltage, 5VDC output voltage and rated output load;
- All index testing methods in this datasheet are based on company corporate standards;
- We can provide product customization service, please contact our technicians directly for specific information;
- Products are related to laws and regulations: see "Features" and "EMC";
- Our products shall be classified according to ISO14001 and related environmental laws and regulations, and shall be handled by qualified units.

MORNSUN Guangzhou Science & Technology Co., Ltd.

Address: No. 5, Kehui St. 1, Kehui Development Center, Science Ave., Guangzhou Science City, Huangpu District, Guangzhou, P. R. China
Tel: 86-20-38601850 Fax: 86-20-38601272 E-mail: info@mornsun.cn www.mornsun-power.com